



MOMENTUM



FORTINA™

THE WARMTH OF WOOD. ENGINEERED IN ALUMINUM.



Material + Performance

Fortina™ is an architectural system that replicates the look and feel of wood slats and battens using aluminum wrapped in a hyper-realistic, non-PVC surface. The result is a lightweight, durable solution suited for a variety of applications.

With a wide range of finishes that closely resemble natural wood, Fortina enhances interior and exterior environments while offering lower cost, reduced waste, easier installation, and greater color consistency than real wood.



Fortina provided a durable solution suitable for our climate to extend the look of the exposed wood roof deck at the interior to the exterior.

*Landon Burg
Architect*

Contents

- Project Inspiration** 04
- What Sets Fortina Apart** 33
- Quick Ship** 34
- Special Order Finishes** 36
 - Interior 36
 - Exterior 38
- Battens vs Slats** 39
- Batten Applications Overview** 40
- Special Order Battens and Slats** 42
 - Batten Profiles 42
 - Decorative Backrails 44
 - Stringer Batten Profiles 45
 - Stringer Accessories 46
 - Direct Attach Batten Profiles 47
 - Slat Profiles 50
 - Slat Accessories 51
- Enhancements** 52
 - LightStrip 52
- Terms and Conditions** 55

CAFÉ STARBUCKS



Dressma

D

TIGER

Kauppakeskus Plaza / Helsinki, Finland



The Griffin Club / Los Angeles, CA



Tetra Hotel / Sunnyvale, CA





Mudd Library, Northwestern University / Milpitas, CA







Tetra Hotel / Sunnyvale, CA

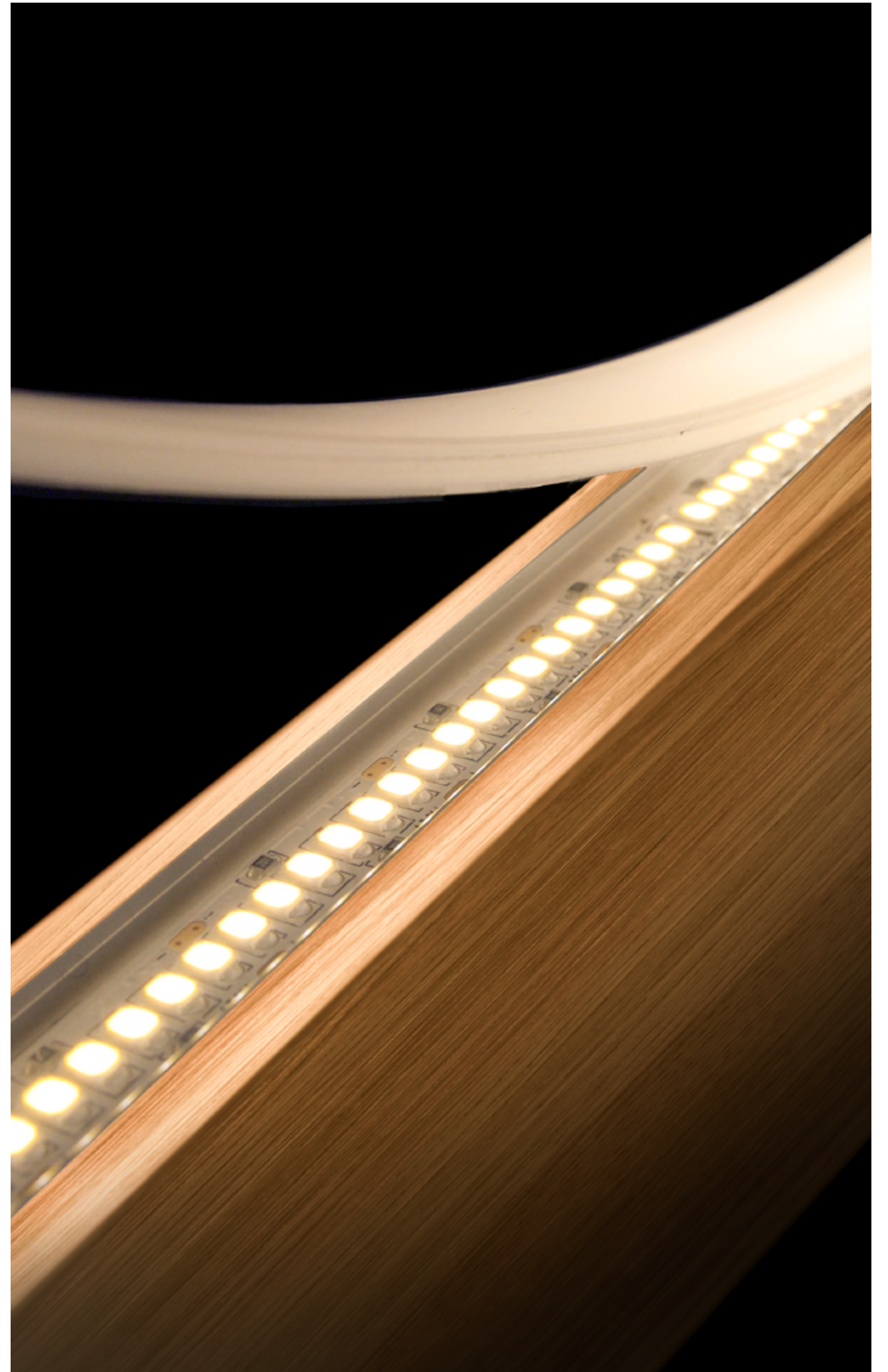





Marion Fire Station / Marion, IA





"Jacob was excellent! He is the only one that I've been able to understand and he helped me with my problem fast and efficiently. He was A+ with everything!"
Customer Comment





What Sets Fortina Apart

Benefits

Performance you can see and durability you can rely on.



Authentic Wood Look

Captures the warmth and grain of real wood without the cracking or warping of natural lumber.



Class A Fire Rated

Meets ASTM E84 Class A performance standards for all applications.



Lightweight & Stable

Aluminum construction reduces structural load and resists movement over time.



Low Maintenance

Easy to clean with a durable, scratch-resistant surface designed for everyday use.



Weather Resistant

Withstands sun exposure, moisture, and changing climates while maintaining quality.



Consistent Finish

Manufactured for uniform color and controlled grain across large installations.

Multi-Layer Film Technology

An engineered surface system bonded to anodized aluminum for lasting color, durability, and wood realism.

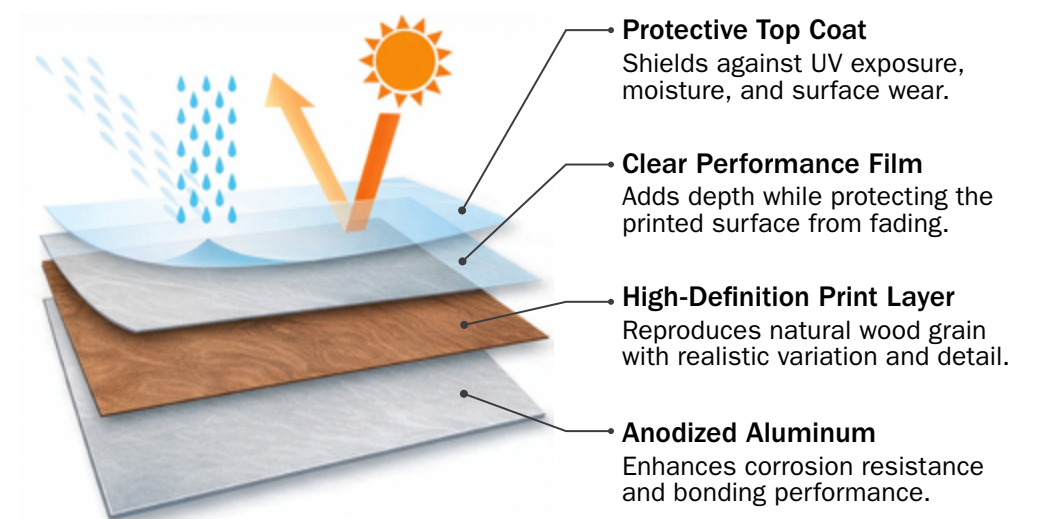



Quick Ship

Fortina. On an Accelerated Timeline.

Fortina's Quick Ship program offers a curated selection of Fortina's most specified profiles and finishes, rated for both interior and exterior applications—available on an accelerated timeline. Available in select wood-inspired finishes and anodized aluminum options, Quick Ship delivers the same Fortina system without extended lead times.

Square corner keys—available for select THS Quick Ship profiles*—allow battens to be miter-cut and joined at 90°, creating a refined corner detail.

Manufactured and assembled in the United States, Quick Ship orders ship within 72 hours—keeping projects on track without compromising design intent.



↑
Scan to learn more about our Quick Ship Program.

Finishes

Wood Grain



TAR-758
Vent Walnut N



TAR-005
Rican Oak



TAR-021
Criollo Elm



TAR-647
Earl Walnut M



TAR-532
Cherry Line M



TAR-004
Rokko Cedar



TAR-2035
Axis Oak N



TAR-2122
Lunta Elm

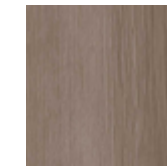

TAR-028
Pacific Gray

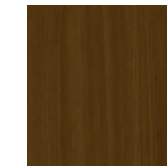

TAR-775
Carina Elm D

Anodized



AB1010
Silver



AB1020
Champagne

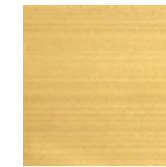

AB1100
Light Gold



AA1090
Rose Gold



AB1030
Golden Bronze

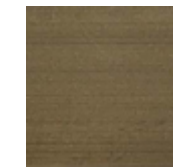

AB1040
Light Bronze

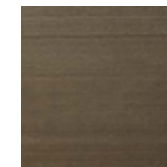

AB1050
Medium Bronze

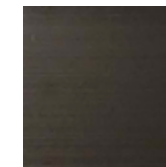

AB1060
Dark Bronze

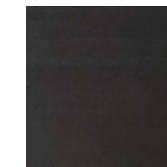

AB1070
Deep Bronze

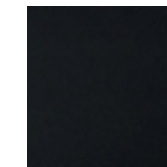

AB1080
Black

Profiles



THS-3010*
1" x 4"
30mm x 100mm

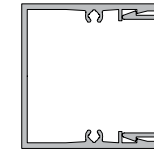

TLKS-5050 + CLKU-50
2" x 2"
50mm x 50mm

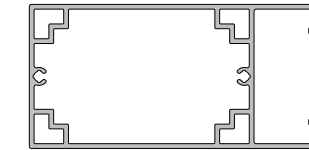

THS-5010
2" x 4"
50mm x 100mm



THS-5015
2" x 6"
50mm x 150mm



THS-5025*
2" x 10"
50mm x 250mm

Mitered Joints

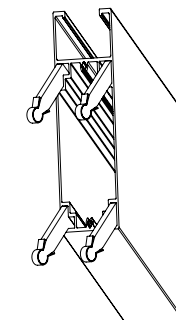

Mitered batten with corner key

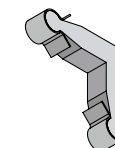

Corner key connection detail

End Caps

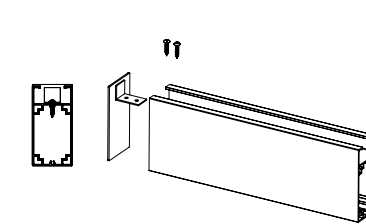

Bracketed
Used on: THS 3010, 5010, and 5015 Battens
Material: Steel
Finish: Powder coat, anodized, or wood grain

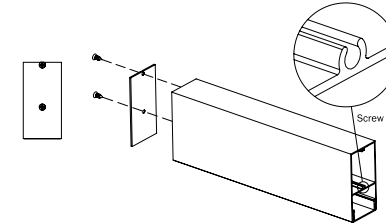

Screw-On
Used on: TLKS (Direct-Attach) Battens
Material: Aluminum
Finish: Powder coat, anodized, or wood grain

Special Order Finishes | Interior

All finishes shown are available by special order. For current lead times and minimum order quantities, please contact your Fortina representative.

Wood Grain

Please note that the color in the brochure may vary from the actual product.

Wood Grain

Non-Wood Grain

Special Order Finishes | Exterior

All finishes shown are available by special order. For current lead times and minimum order quantities, please contact your Fortina representative.

Wood Grain



Non-Wood Grain



Anodized



*Semi-Exterior

Please note that the color in the brochure may vary from the actual product.

Battens vs Slats



Battens

A batten is an individual linear element installed with space between each profile. Traditionally used to create shade and ventilation, battens are now widely used as architectural features on walls and ceilings. The spacing between battens creates depth, shadow lines, and visual rhythm.



Fortina Battens are aluminum extrusions wrapped in a non-PVC film, available in a wide range of profiles and finishes for interior and exterior applications.

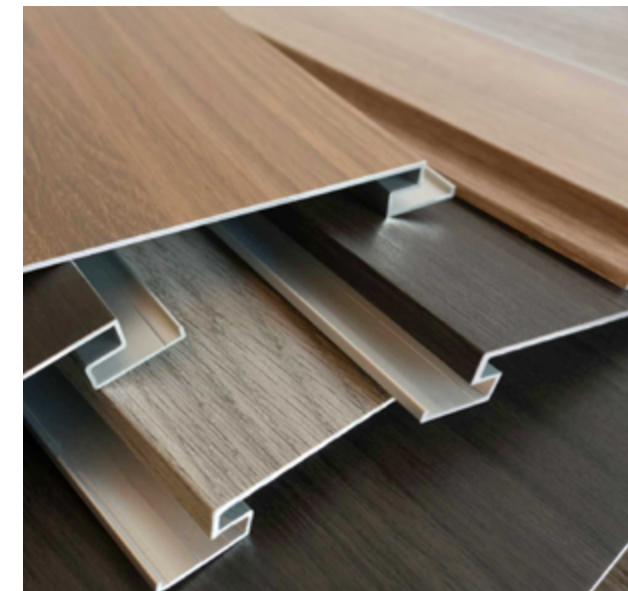

Slats

A slat is a linear profile designed to interlock or install continuously, creating a more uniform surface. Unlike battens, slats minimize spacing and produce a tighter, more consistent appearance.



Fortina Slats are lightweight aluminum profiles available in multiple widths and reveal options, finished to coordinate seamlessly with Fortina Battens.

Batten Applications Overview

Interior Applications

Vertical On Wall

Direct Attachment with interlocking batten and back rail. Screw back rails at desired locations vertically to the wall and lock batten into it. It is recommended that you secure the back rail with small screw on side at top and bottom.

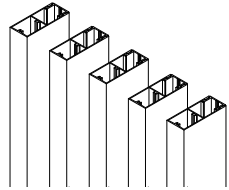

Stringer Mounted battens attach horizontally to stringers, which are attached to the wall structure with L-brackets, Unistrut, L-angles or similar. Stringers will be pre-notched to create the desired Batten spacing. Battens are secured to the stringers with special Fortina clips.

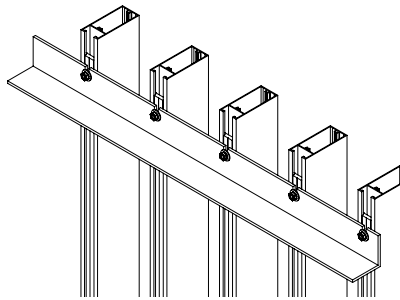

Horizontal On Wall

Direct Attachment with interlocking batten and back rail. Screw back rails at desired locations horizontally into the wall and lock Batten into it. It is recommended that you secure the back rail with small screw on side at top and bottom.

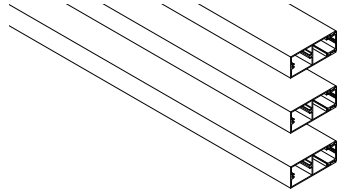

Stringer Mounted battens attach vertically to stringers, which are attached to the wall structure with L-brackets, Unistrut, L-angles or similar. Stringers will be pre-notched to create the desired Batten spacing. Battens are secured to the stringers with special Fortina clips.

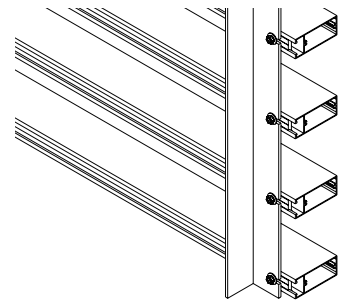

Ceiling

Direct Attachment with interlocking Batten and back rail. Screw back rails at desired locations into the ceiling and lock Batten into it. It is recommended that you secure the back rail with small screw on side at each end.

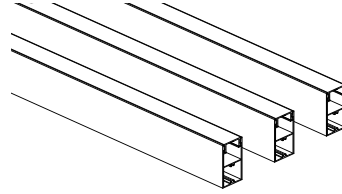

Stringer Mounted battens attach horizontally to stringers, which are supported from the ceiling structure with rods, Unistrut or L-brackets. Stringers will be pre-notched to create the desired batten spacing. Battens are secured to the stringers with special Fortina clips.

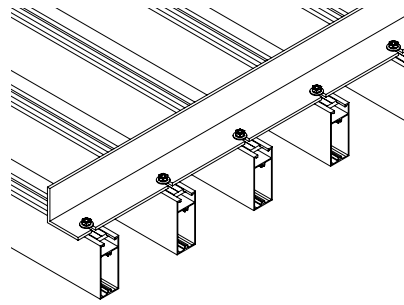

Floor-to-Ceiling

Floor-to-Ceiling battens use end plates to support vertically oriented arrays of decorative aluminum battens, creating continuous floor-to-ceiling screens. This solution is ideal for tight clearance conditions, such as in front of glazing, where access to the back of the batten is limited. Battens are individually secured at the floor and ceiling with attachment brackets.

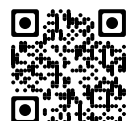
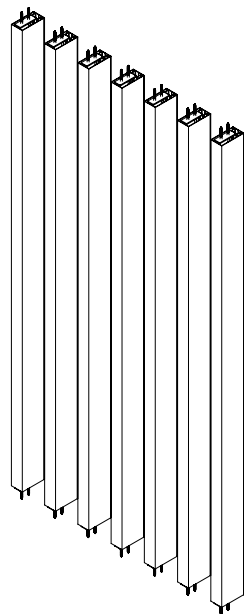
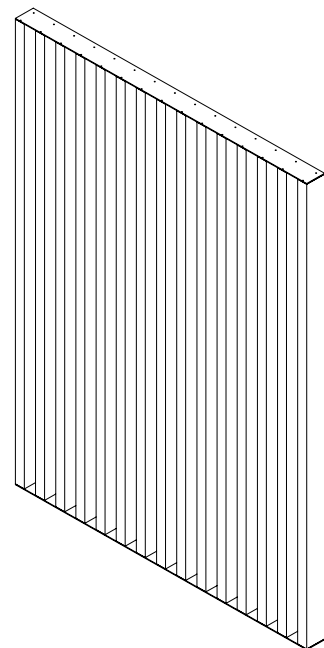

Scan to access Fortina Technical documents.

Exterior Applications

Vertical On Wall

Stringer Mounted battens attach horizontally to the wall structure with L-brackets, Unistrut, L-angles or similar. Stringers will be pre-notched to create the desired Batten spacing. Battens are secured to the stringers with special Fortina clips.

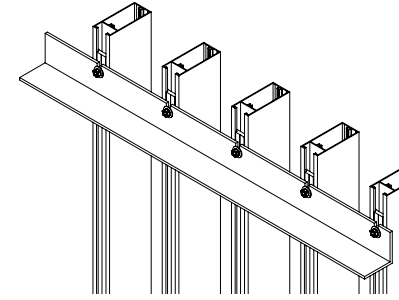

Horizontal On Wall

Stringer Mounted battens attach vertically to the wall structure with L-brackets, Unistrut, L-angles or similar. Stringers will be pre-notched to create the desired Batten spacing. Battens are secured to the stringers with special Fortina clips.

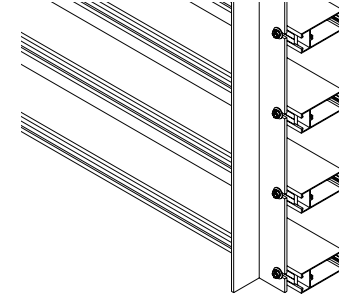

Special Order | Battens

Available for All Batten Applications

Square 15



TLBS-1550
1/2" x 2"
15mm x 50mm



TLBS-1510
1/2" x 4"
15mm x 100mm

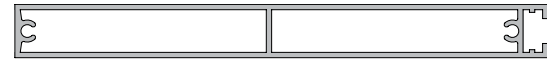

TLBS-1515
1/2" x 6"
15mm x 150mm

Square 20

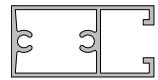

THS-2040
3/4" x 1 1/2"
20mm x 40mm



THS-2060
3/4" x 2 1/4"
20mm x 60mm



THS-2080
3/4" x 3 1/4"
20mm x 80mm



THS-2010
3/4" x 4"
20mm x 100mm



THS-2015
3/4" x 6"
20mm x 150mm

Square 25



THS-2570
1" x 2 3/4"
25mm x 70mm



THS-2580
1" x 3 1/4"
25mm x 80mm

Square 30

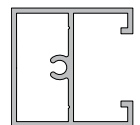

THSN-3030
1 1/4" x 1 1/4"
30mm x 30mm

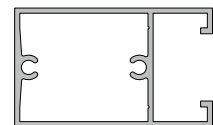

THS-3050
1 1/4" x 2"
30mm x 50mm



THS-3060
1 1/4" x 2 1/4"
30mm x 60mm



THS-3075
1 1/4" x 3"
30mm x 75mm



THS-3080
1 1/4" x 3 1/4"
30mm x 80mm



THS-3010
1 1/4" x 4"
30mm x 100mm



THS-3015
1 1/4" x 6"
30mm x 150mm

Square 40

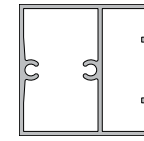

THS-4040
1 1/2" x 1 1/2"
40mm x 40mm

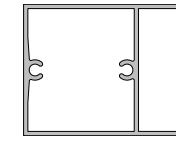

THS-4050
1 1/2" x 2"
40mm x 50mm

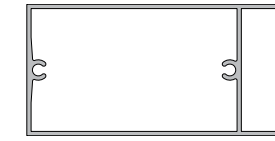

THS-4080
1 1/2" x 3 1/4"
40mm x 80mm

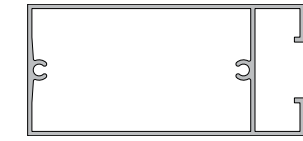

THS-4010
1 1/2" x 4"
40mm x 100mm

Square 50

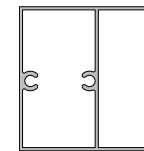

THSN-5050
2" x 2"
50mm x 50mm

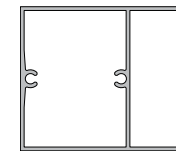

THSN-5060
2" x 2 1/4"
50mm x 60mm



THSN-5010
2" x 4"
50mm x 100mm



THSN-50125
2" x 5"
50mm x 125mm



THS-5015
2" x 6"
50mm x 150mm



TPS-50200
2" x 8"
50mm x 200mm



TPS-50250
2" x 10"
50mm x 250mm

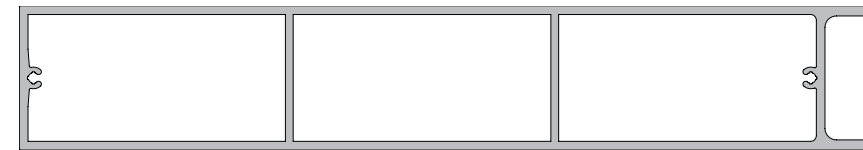

TPS-50300
2" x 11 3/4"
50mm x 300mm

Imperial measurements are rounded to the nearest 1/4".

Special Order | Decorative Backrails

Interior, Exterior Wall, and Ceiling Applications with Stringers

Backrails

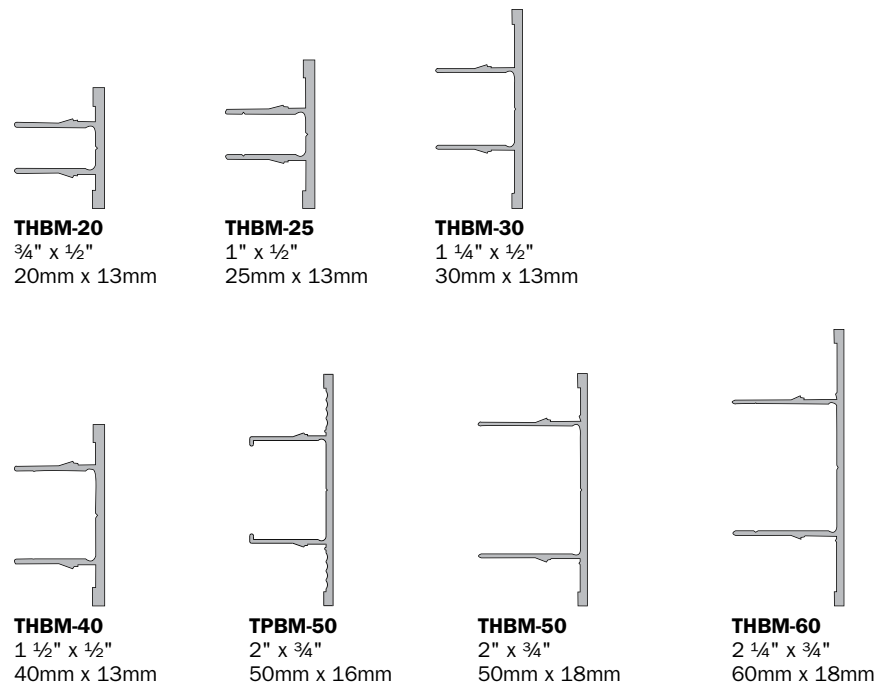

End Caps

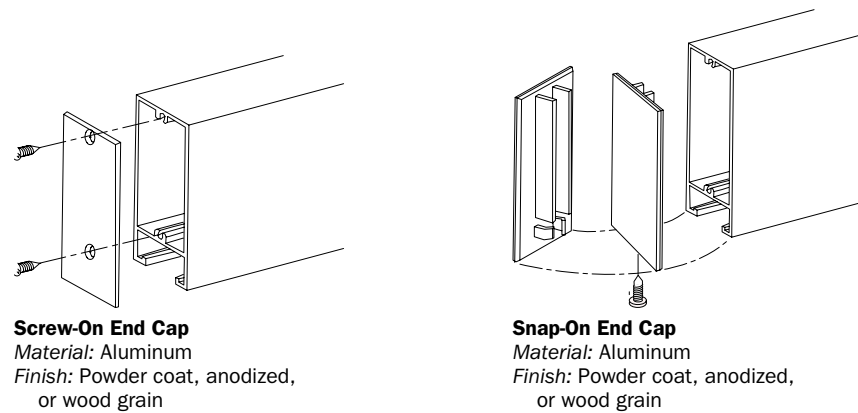

Special Order | Stringer Battens

Interior, Exterior Wall, and Ceiling Applications with Stringers

Square 60

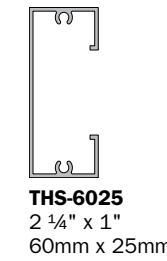

Square 75

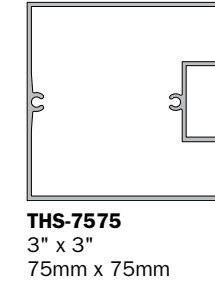

Square 100

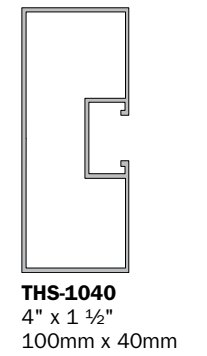

Round

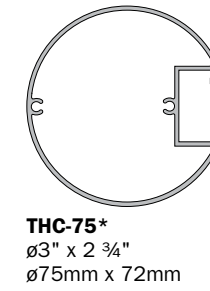
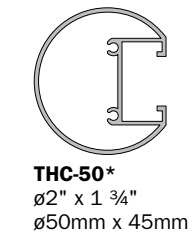
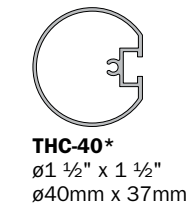
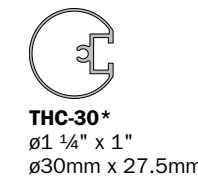

*Can utilize a finished THBM-60 backrail.
Imperial measurements are rounded to the nearest 1/4".

Special Order | Stringer Accessories

Interior, Exterior Wall, and Ceiling Applications with Stringers

Stringer Attachment Clips

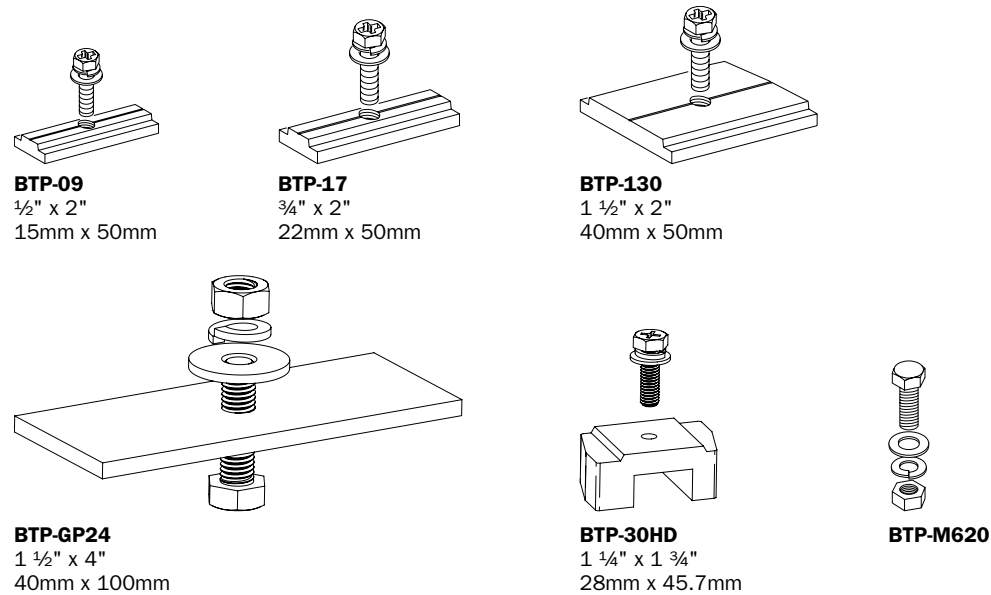

Stringers

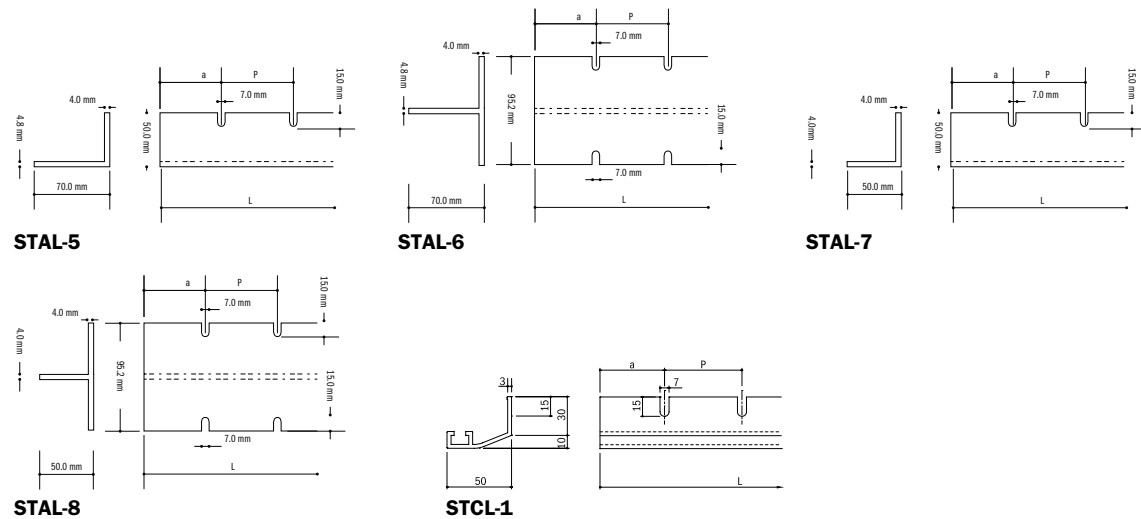

Stringer Fittings

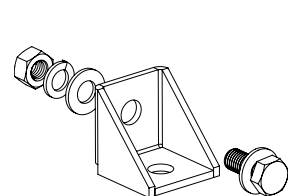

BTS-505 Welded Gusset
Material: Steel
Finish: Black powder coat
Used with: STAL-7/STAL-8

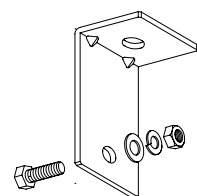

BTS-4080ST
Material: Steel
Finish: Polished chrome
Used with: STCL-1

Floor-to-Ceiling L-Brackets

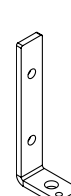

TBF L-Bracket Lite
Finish: Black Powder Coat
Compatible with:
THS-2010, 2015, 2040,
2060, 2080, 2570,
2580, 3050, 3060,
3075, 3080, 4040,
4050, 4080, 5060
THSN-5050

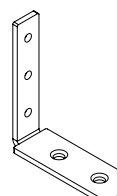

TBF HD L-Bracket
Finish: Black Powder Coat
Compatible with:
THS-3010, 3015,
5010, 5015, 50125,
6012

Special Order | Direct Attach Battens

Interior and Exterior Wall, and Ceiling Direct Attachment Applications

Attachment 20

Utilizes backrail CLKU-20

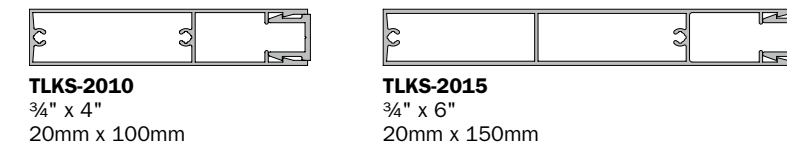
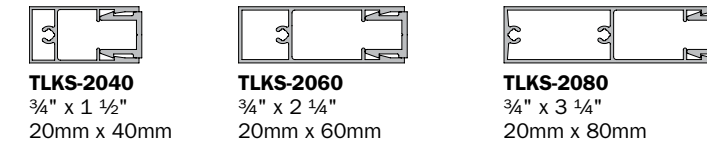

Attachment 30

Utilizes backrail CLKU-30

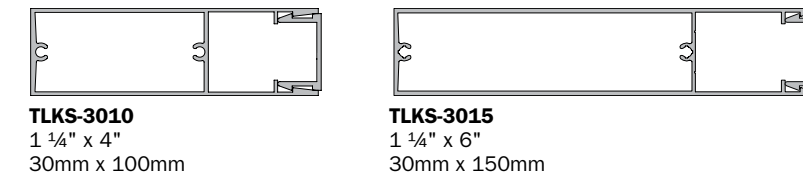
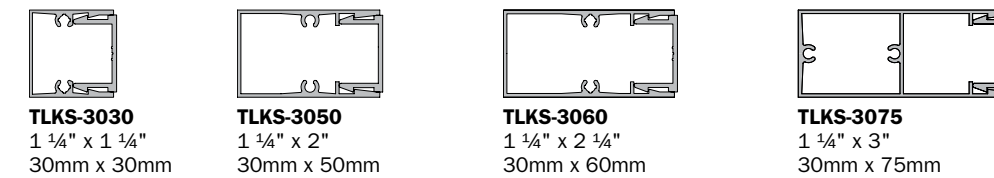

Attachment 40

Utilizes backrail CLKU-40

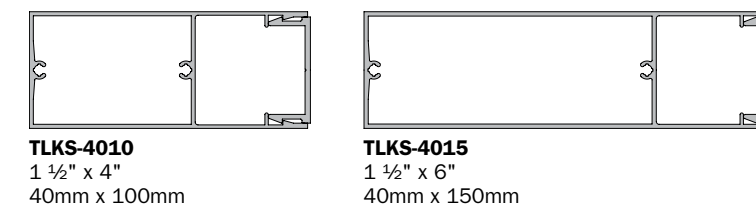
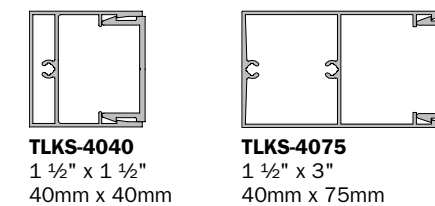

Imperial measurements are rounded to the nearest 1/4".

Special Order | Direct Attach Battens

Interior Wall and Ceiling Direct Attachment Applications

Attachment 50

Utilizes backrail CLKU-50

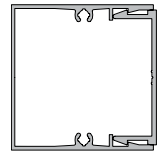

TLKS-5050
2" x 2"
50mm x 50mm

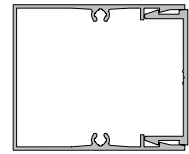

TLKS-5060
2" x 2 1/4"
50mm x 60mm

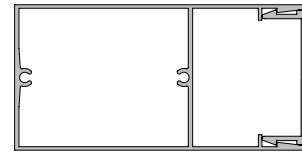

TLKS-5010
2" x 4"
50mm x 100mm



TLKS-1030
4" x 1 1/4"
100mm x 30mm

Attachment 100

Utilizes backrail CLKU-100



TLKS-5015
2" x 6"
50mm x 150mm

End Caps

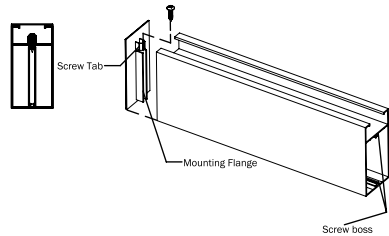

Bracketed
Used on: THS 3010, 5010,
and 5015 Battens
Material: Steel
Finish: Powder Coat to Match
Batten Finish

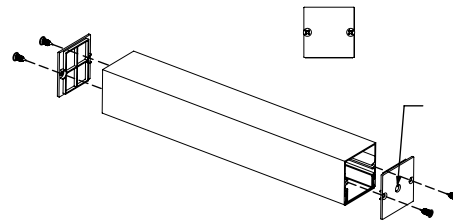

Screw-On
Used on: TLKS (Direct-Attach)
Battens
Material: Aluminum
Finish: Powder Coat match or
Wood Grain



Special Order | Slat Profiles

Interior and Exterior Wall Applications

Standard Style with 10mm Reveal

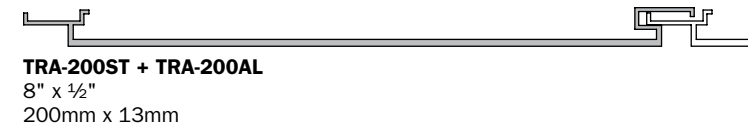
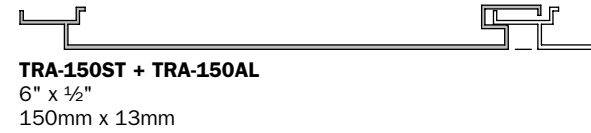
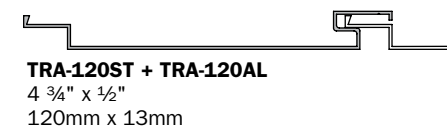
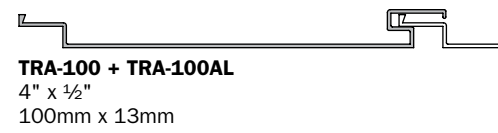

Flat Style with No Reveal

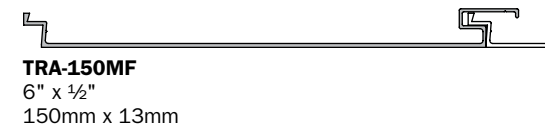
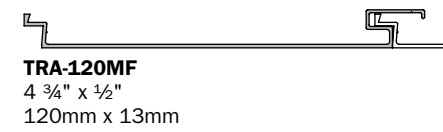
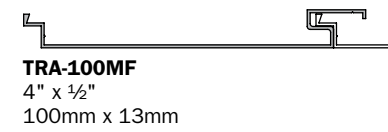

Example Slat Styles

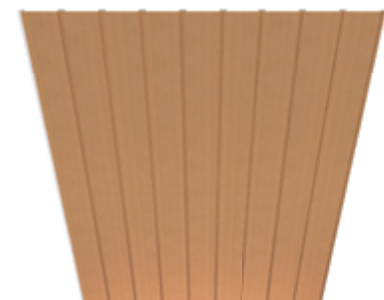

Standard Style with Wood Grain Reveal

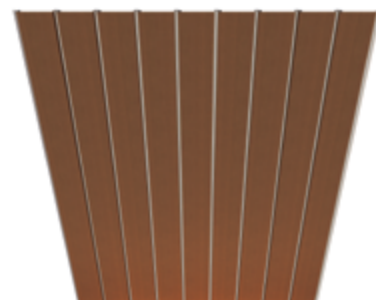

Standard Style with Aluminum Reveal

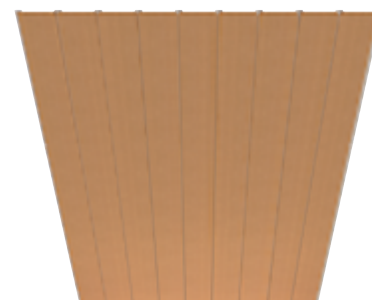

Flat Style with No Reveal

Special Order | Slat Accessories

Interior and Exterior Wall Applications

Trims and Edge Treatment

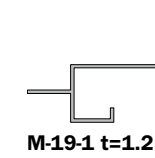
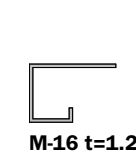

Exterior Corner Trim

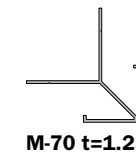

Interior Corner Trim

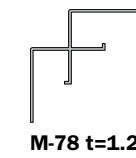

H-Joints

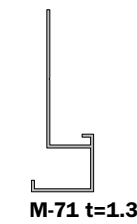
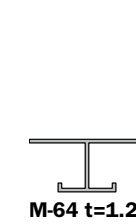

Corner Trim

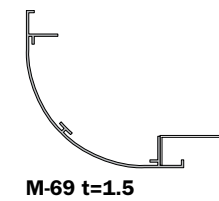
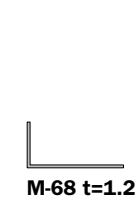
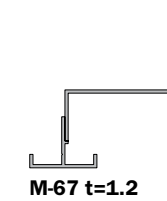
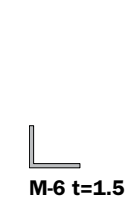



System Enhancements | LightStrip

Fortina's wood-inspired battens can be integrated with energy-efficient LED lighting, creating a seamless combination of material and illumination. LightStrip enhances depth, rhythm, and atmosphere while providing practical ambient light.

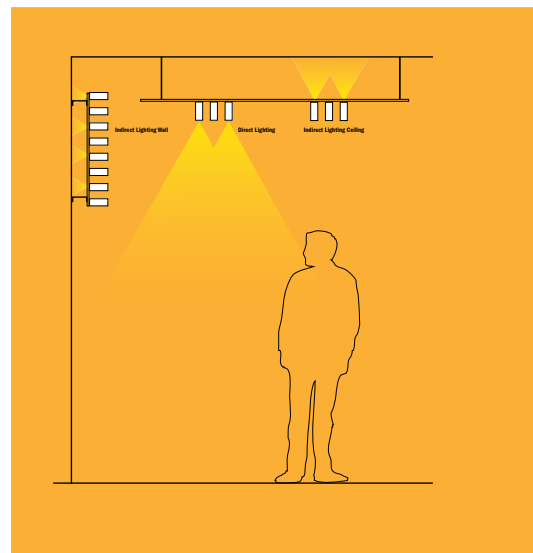

Lighting Applications

Direct Lighting

LightStrip is integrated within the Fortina Batten and paired with LED diffuser back rails that clip seamlessly into place. The light source faces outward, creating defined lines of illumination for a clean, modern effect.

Indirect Lighting

Integrated within the Fortina Batten but concealed from direct view, indirect lighting casts a soft halo around each profile. This approach reduces glare and enhances depth within the space.

Light Grazing

Light grazing positions linear light at an angle along a vertical surface. When used with Fortina, the technique accentuates the texture and spacing of battens through contrast and shadow.

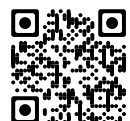

↑
Scan to learn more about
Fortina LightStrip.



EIT Benefit Funds / Alsip, IL

Terms and Conditions

QUOTE BY PHONE

1-800-350-4127 (Outside Northern California)
1-650-593-4127 (Northern California)

QUOTE/ORDERING BY E-MAIL

MAIL@B N I N D . C O M (Ready 24 hours a day)

CUSTOMER SERVICE

Customer service is available 8:00 am to 5:00 pm (PST) Mon. – Thurs. and 8:00 am to 12:00 pm on Fri. to answer your inquiries regarding products, quotes or orders.

WARRANTY

We fully support the quality of our product. If there are any manufacturing defects within a year of delivery, please contact our Customer Service Department by phone or e-mail for assistance.

PRODUCT WARRANTY LIMITATIONS

The Customer is purchasing the fixtures in an "as-is" condition, unless otherwise reported to the Company pursuant to [the inspection provision in the contract], as of the date of delivery and specifically and expressly without any warranties, representations or guarantees, either expressed or implied, except as set forth below, as to its condition, fitness for any particular purpose, merchantability, or any other warranty of any kind, nature or type whatsoever from or on behalf of the seller.

The Company hereby warrants to the Customer and its successors and assigns that the product supplied to the Customer is constructed only for the use and purposes contemplated by the Customer set forth in the contract; and the Company, immediately prior to the delivery of the product had good and lawful right to sell the product, and that there is hereby conveyed to the Customer on the date of delivery, good title to the product, free and clear of all liens, claims, encumbrances and rights of others.

WEBSITE / PRINTED MATERIALS

The copy has been reviewed to present information as accurately as possible. If an error is found in description or pricing, or the item has been discontinued, yet not updated, B+N reserves the right to correct it at the time it was discovered.

PRODUCT OFFERINGS AND MATERIAL FINISHES ARE SUBJECT TO CHANGE AT ANY TIME.

ORDER SHIPMENTS ESTIMATES

Orders in stock will ship via ground in 2 - 5 days, unless another service level is requested by the customer.

BACK ORDERS

Unless otherwise noted, back orders will ship when they are back in stock at our facility. Your Sales Administrator will keep you advised on the status of all back orders.

BLANKET ORDERS

Blanket orders are subject to a unique set of Terms & Conditions defined at the time of order placement.

MINIMUM ORDER REQUIREMENTS

\$500 threshold must be reached to place an order.

STORAGE

Storage fees will be assessed after 30 days for all materials that were scheduled to ship but were delayed for customer related reasons at no fault to B&N Industries. Fees will be assessed weekly at \$500 or 5% of the total order, whichever is greater. If an order is paid in full, then the storage fees must be cleared prior to shipment. If an order is partially paid for, then the remaining balance on the order plus storage fees must be paid prior to shipment.

CANCELLATION AND RETURN ITEMS

1. Stock items must be returned within 30 days, in re-sellable condition. Return of stock items may incur a 25% re-stocking fee. Freight charges on returns are the customer's responsibility. A return authorization is required for all returns. Items returned without the proper authorization will not be accepted. B+N assumes no liability for customer returns which arrive damaged due to shipment transportation.
2. Non-stock items purchased may not be returned.
3. Prepaid material that remains beyond the 30-day original delivery schedule prior to cancellation will also be subject to storage fees.

FREIGHT AND MULTIPLE SHIPMENTS

1. The following will result in additional charges unless otherwise stated on your quotation:
 - Shipments to multiple destinations or split shipments to the same location.
 - Customer requesting custom packaging (includes breakout into multiple packages) and shipped to one location.
2. Collect or 3rd Party Billing shipments are the responsibility of the freight payer.
3. Freight quotations are subject to re-quote at any time prior to the order being placed or at time of shipment if shipment is delayed.
4. Customer is responsible to arrange and pay for International freight, as quotes are for transportation only. Freight quotes provided by B&N do not include the broker, customs duties, fees or taxes. That is the responsibility of the customer to obtain and pay directly to the source. Broker information must be provided prior to shipping.
5. Weights and measurements may change due to changes in suppliers and/or packaging.
6. B&N is unable to guarantee delivery times or dates. Delivery times and dates are the responsibility of the shipping agent.
7. Regarding split shipments: On occasion, an order may ship from multiple locations based on availability.

PRODUCT DISCREPANCIES AND DAMAGES VIA SHIPMENT

1. Customer must inspect items upon delivery for damage or discrepancy. Please refer to B+N's Delivery Shipper Checklist Info document for terms.

The Delivery Checklist can be found here: <https://B N I N D . C O M /resources/technical-data>

2. B+N accepts no liability for damage incurred during shipping. Any damage found at time of delivery must be noted by customer on delivery receipt and signed/ initialed by driver. Customer is to retain all packaging with damaged items for an on-site inspection by carrier.
3. For damage on 3rd party or collect shipments, the customer is responsible for filing the claim with the carrier for financial reimbursement.
4. If any product arrives in damaged condition, a freight claim must be filed with the delivering carrier. Retain packing material and note on the Bill of Lading "DAMAGED". Our Customer Service Department will assist you with any questions regarding filing a freight claim.
5. All claims regarding shortages and freight damages must be presented WITHIN 7 DAYS of receiving the shipment.

PAYMENT METHODS AND TERMS

ACH, Wire, and Company Checks
· Banking information can be provided upon request for electronic payment options

Credit Cards (subject to 2.5% processing fee)
· We accept VISA, MASTERCARD, AMERICAN EXPRESS.

1. Payment is due in full prior to shipping of product for all PREPAID ACCOUNTS. We do not ship COD. For payments made by check or bank transfer, the order will be processed upon receipt and approval of check or receipt of funds.
2. Consideration for establishing terms requires a combined order amount of \$1,000,000+.
3. Approved repeat customers may qualify for NET terms at B&N's discretion if sufficient volume is reached. A credit application must be completed with the necessary references. Please allow 2-3 weeks for processing. All custom orders outside of a standard project scope will continue to require a 50% deposit.

SALES TAX

Due to the Wayfair vs South Dakota ruling all orders are subject to sales tax in the state that the material is delivered to unless a valid resale certificate is provided. Due to uncertain Economic Nexus requirements sales tax can be added to any order after a quote has been provided.

1. Taxable orders paid for by the customer and will-called at our California facility are taxed at the current rate for San Mateo County.

PROTOTYPES, DRAWINGS, TOOLING, AND FIXTURES

1. Drawings provided by B+N are the exclusive property of B+N Industries, LLC.
2. Prototypes made from drawings that are not detailed and approved by B+N Industries, LLC., or have been supplied via verbal instruction from the customer, are subject to the interpretation of B+N Industries, LLC.
3. Tooling dies and fixtures made and used exclusively for a job or customer, remain the property of B+N Industries, LLC., unless otherwise established.

PHOTOGRAPHY OF COMPLETED PROJECTS

B+N Industries, LLC. reserves the right to photograph a completed project that has utilized our product offerings and retains the rights to use the photographs in advertising, on our website, public relations and all marketing materials.

FORTINA SPECIFIC ORDERS WARRANTY WARRANTY

We support the quality of the Fortina product for 10 years. For more information, please visit our Warranty section.

CANCELLATION AND RETURN ITEMS

Fortina is considered a custom made to order line, therefore, may not be returned. If an order is canceled which is in production the customer is liable for paying for all products ordered.



www.bnind.com | 800.350.4127



[Learn More](#)